

Editorial

Coexistence

A number of technological revolutions was necessary before it became finally possible to convert originally analog signals to digital data values with high precision, to transmit them, to store them, and to reproduce them in analog form with practically no error, i.e. with negligible information distortion or losses. One result of this development is digital tape recording. In comparison with analog recording it can rightfully claim to be revolutionary. Nevertheless, digital and analog magnetic recordings coexist today in the professional sector. Different applications lead to different cost/benefit analyses which means that both processes can be justified.

The technical evolution of analog recorders has not come to an end. In the last edition of Swiss Sound we introduced the A 820 multichannel recorder:

a machine which by virtue of its outstanding tape deck characteristics, soundheads made of amorphous metal, microprocessor-controlled calibration, high flexibility, and integrable noise reduction systems (Dolby A, SR, and Telcom) as well as its ease of use establishes new dimensions in the field of analog recording.

Today's edition presents the first of a number of articles on the D820X, our digital twin DASH tape machine. With DASH Studer has selected a rugged and established format which in the present version guarantees exceptionally high data reliability because of the twin recording process. Although the D820X exploits new technologies, it is still largely based on the know-how and experience that Studer engineers have acquired from the evolutionary development of the analog technology. The tape deck and the transport control, including their excellent specifications, have been inherited from the A 820. For this reason the user will find the same operating philosophy on both machine types, and both feature the same software monitoring of all operating parameters. Both machines feature the same concealable secondary keypad with user prompts via LCD. An ingenious menu technique ensures that no difficulties are encountered for setting PCM related parameters.

The development of A820, A820 multichannel, and D820X tape recorders has shown that new technologies cannot be mastered without resorting to traditional know-how.

The PCM technology imposes new, more demanding requirements on the analog technology, which consequently does not become obsolete but presents new challenges in the areas of amplifier and filter designs, AD and DA converters, as well as in the drive and control technique for precision mechanical components. Our engineers and designers have accepted these challenges by developing new forms of interdisciplinary cooperation. Pooling of traditional and advanced know-how in projects such as the D820X ensures maximum usefulness of the product.



Werner Hinn (41)
After basic commercial training he received his mercantile diploma in 1965. Commercial practice in administration, sales, and banking. 1968-73 Electrical engineering studies at the Swiss Institute of Technology, ETH, Zurich. 1973-86 Research, development, and licensee consultant for the American company Laboratories RCA Ltd. in Zurich. Holder of twenty US patents with worldwide applications in the areas of TV studio engineering, home TV, IC development, analog and microprocessor based control systems, analog and digital signal processing, fast DA converters. Since March 1986 product development manager at Willi Studer AG.

Werner Hinn

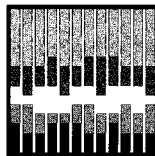

Studer D820X Digital 2-Channel Tape Machine

The digital «mile stone»

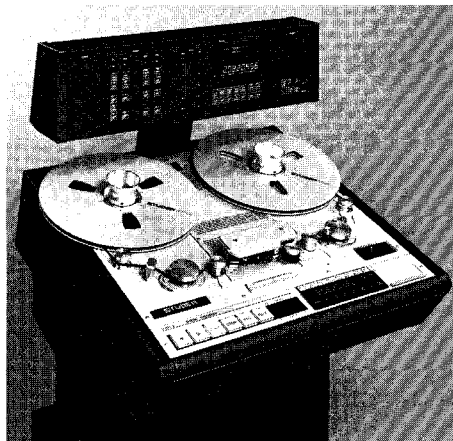

D820X Twin DASH two channel tape recorder: Studer quality in digital technology. The D820X accommodates 14" tape reels providing over 2 hours of uninterrupted recording time.

In contrast with the innovative steps in the age of analog audio technology, the jump into the digital recording process is characterized by a new dimension. The acquisition and storage of complex audio signals in the form of absolute numeric values represents a completely new technique which imposes new demands on

the developer as well as the user. For this reason we shall publish a number of reports that familiarize our readers with the principle of digital recording and the digital 2-channel tape recorder D820X.

In the first report, a brief general overview is given of the complete machine and its background. In later articles, the implemented technology and related formats will be discussed in detail.

SWISS 19 SOUND

Read in this issue:

	page
● Digital tape recorder D820X	1
● B215: automatic calibration	4
● New studio for Schwarzfilm-technik Inc.	6
● Compact mixing console 963	8
● B251: damping coefficient	10
● Who is who: Val P.Ortega	11

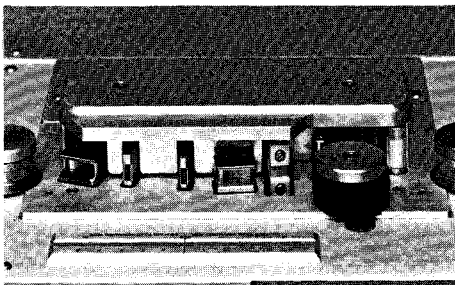

Extremely stable headblock with thin-film 'inline' recording heads and ferrite reproduce heads.

Digital recording: open reels and stationary heads

For approx. 5 years, stereo digital audio recording systems have been based on modified video recorders and so-called PCM adapters which translated the analog signals into a pseudo-video signal, which is usually recorded on a U-matic type recorder. This allows little more than one hour of stereo recording time, at 44.1 kHz sampling frequency.

Digital audio recorders with open reels and stationary heads have been developed because they offer more flexibility than the above mentioned system, at much lower costs.

E.g. an open reel stationary head recorder allows most of the things we are used to in analog recording, like off-tape monitoring during record mode, two channel operation, varispeed, tape cut editing and, of course, longer recording times. As digital audio tape is half as thick as analog tape, more than two hours can be recorded on an 14 inch reel. This is of great advantage in live recording, post production and CD Mastering. The D820X runs at 48 kHz as well as 44.1 kHz, and accepts 'old' 44.056 kHz formatted recordings.

The D820X machine: A Twin DASH Recorder

The D820X recorder runs at 15 ips tape speed at 48 kHz sampling frequency, and is built according to the so-called Twin DASH Format.

'Twin' indicates the DASH version which is implemented in the Studer D820X. It indicates that each audio sample has its twin version somewhere on the tape. So every sample is recorded twice.

'D.A.S.H.' stands for Digital Audio Stationary Head. DASH refers to the tape format specification which is supported by Studer, Sony, Teac and Matsushita and allows competitive companies to build compatible digital audio tape machines.

It is the first time that digital audio recorders which are developed and manufactured by strongly competitive companies, have proved operational compatibility out in the field.

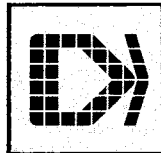

Applications of the D820X

The D820X lends itself extremely well to studio mastering, live recording, post production and CD-tape mastering where off-tape monitoring and robustness are at a premium.

Digital inputs and outputs with digital gain setting allow direct transfer from and to other digital sources, like digital consoles or multitrack machines.

The machine can be slaved to a number of external digital audio or video clocks, and allows complete integration in a synchronizing complex.

The D820X concept

Tape transport: The D820X is built on the same tape transport as the A820, which gives it the advantage of software controlled DC-motors for spooling and capstan. Due to the thinness of digital tape, a careful spooling and tape handling mechanism is of importance.

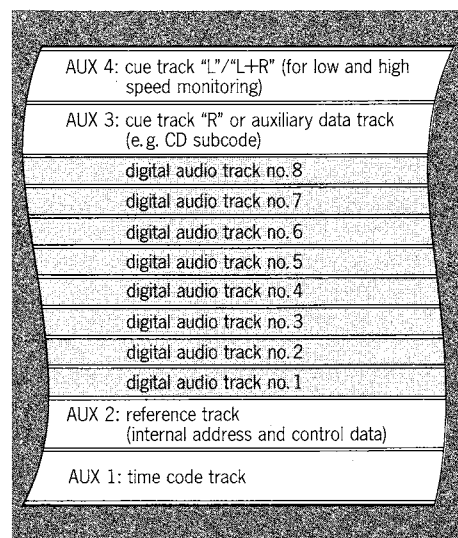

Track geometry and arrangement for 1/4" tape with 12 tracks: Twin DASH at 15 ips tape speed.

Head block and electronics: Specially developed thin-film recording and ferrite playback heads are used. On the 1/4" tape, 12 tracks are written. Eight for the two digital audio channels, and four tracks for auxiliary use such as cueing and time code. These heads are 'in-line', meaning that all 12 tracks are in one head stack, so no additional heads are necessary for the auxiliary tracks.

The head electronics are in an easy accessible 'cage' right under the tape deck.

Transport electronics: Transport electronics are hardware compatible with the A820 and are located in the electronics rack under the tape transport, together with the auxiliary track electronics.

Digital electronics: All digital audio hardware, from analog-digital-converters to signal processing electronics is functionally implemented on boards in the so-called PCM box. This box is self-contained, i.e. it can be produced, tested and serviced as a separate entity. No adjustments are necessary, processing is completely digital, including the filtering of the off-tape signals.

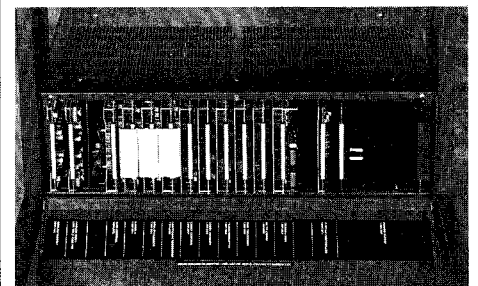

The entire PCM electronics is optimally accessible and concentrated in a separate box.

Human interfacing: operating in digital mode. The operation of the D820X is user-friendly and versatile. Familiar (large) keys are used for the transport control. A locator section on the transport deck allows user-definable locating functions. Under a metal cover, another 10 user-definable keys are available for functions such as Sampling Rate 48/44.1 kHz, Emphasis On/Off, Master Safe, Fader Start, Digital/Analog Input Select, Varispeed Select, Varispeed On/Off and External Sync Select.

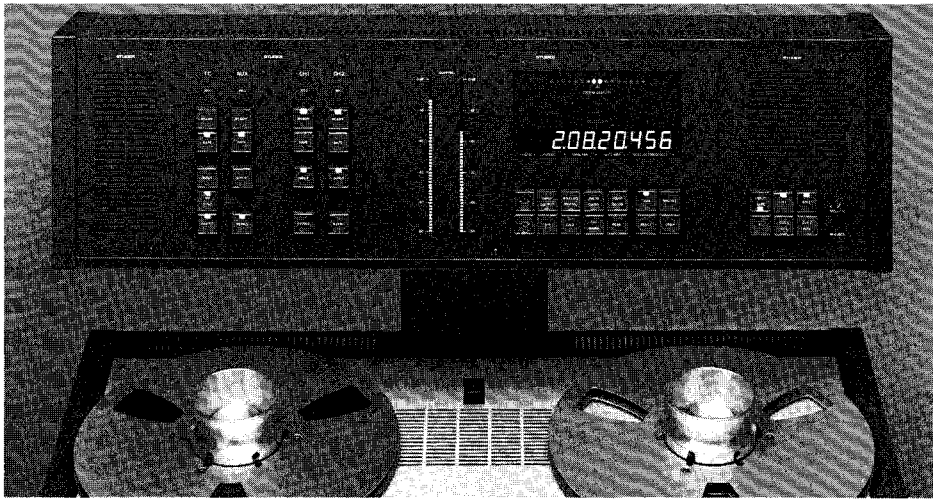

Spacious meter panel with bargraph meters, multifunctional numeric display (standard also for time code) as well as multicolor quality display.



David Walstra (32): Basic training as electrical engineer at the Engineering School Hilversum, Netherlands, with emphasis on data processing and digital transmission techniques. Subsequent studies in digital data processing at the Technical Universities in Eindhoven and Delft. Various activities during one year in an engineering office for telecommunications. Five years as project engineer at Polygram. Participated in the introduction of digital recording system in studio applications. Since the beginning of 1984 at Studer International AG as an allround employee for digital audio. Since the start of 1986 product manager for digital audio at Willi Studer AG. Since about one year also product manager for the activities in the Studer-Philips joint venture.

A program with menu structure offers the user over one hundred additional functions, which can be selected and of which many can be assigned to keys with the help of an LC display and cursor keys. Service modes are included, and can be activated within seconds. The metering panel contains not only peak program meter bargraphs and numerical value display, but as standard equipment also a time code display. A quality display with 8 colored LEDs per channel shows the quality of the signal as read from the tape. This gives the operator an indepth check of the recording on tape, and a very good idea about how healthy his recorder or tape or splice is.

Channel mode controls are similar to those in analog machines, except that there is no sync function, only Repro or Input. The tape passes a record head first, then a playback head. Punch-in and -out is possible.

Both the digital and the auxiliary track can be monitored with the monitor panel. The auxiliary cue tracks have external outputs.

For service and trouble shooting, a terminal with RS232C can be connected to the D820X, in order to communicate with the system controller.

D820X structure

The D820X microprocessors function according to three hierarchical levels. Level one is defined by the Master Processor. Tape transport processor, capstan processor, SMPTE processor, and System Controller are on level two, and communicate with the master via a synchronous serial data adaptor (SSDA).

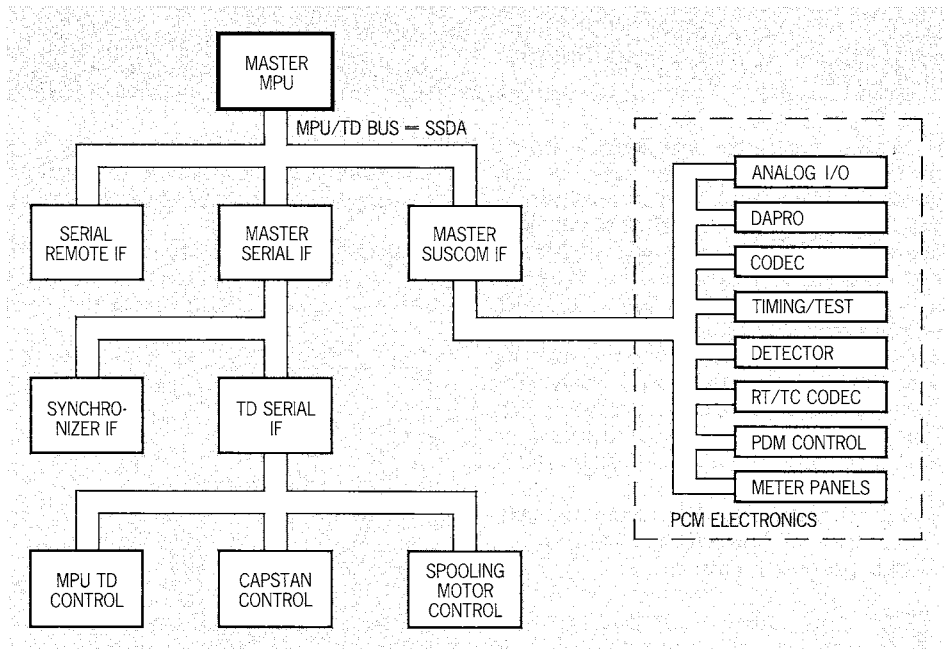

Block diagram of the processors hierarchy in the D820X.

Level three processors are audio processors and cover key and display functions.

The system controller supervises all audio functions and acts as an interface to the SSDA-bus. It also allows the operator to communicate via a terminal or personal computer, for testing or service purpose.

D820X peripherals

Parallel and serial remote control modules are similar to the A820 series, differences are in status indication like sampling frequency only.

The D820X combines well with the Studer TLS 4000 synchronizer, with

which it functions like an analog machine. In some cases a higher quality external reference signal is required, than any synchronizer can actually deliver.

The synchronizer is then able to switch the D820X to pre-selected source signals, like word clock, composite sync or video or just square wave signals.

The D820X is designed for electronic editing. An electronic editor is under development at Studer, which will combine the advantages of the fast 820 transport and high quality audio editing processing.

David Walstra

Revox B215 – automatic calibration

The perfect compromise

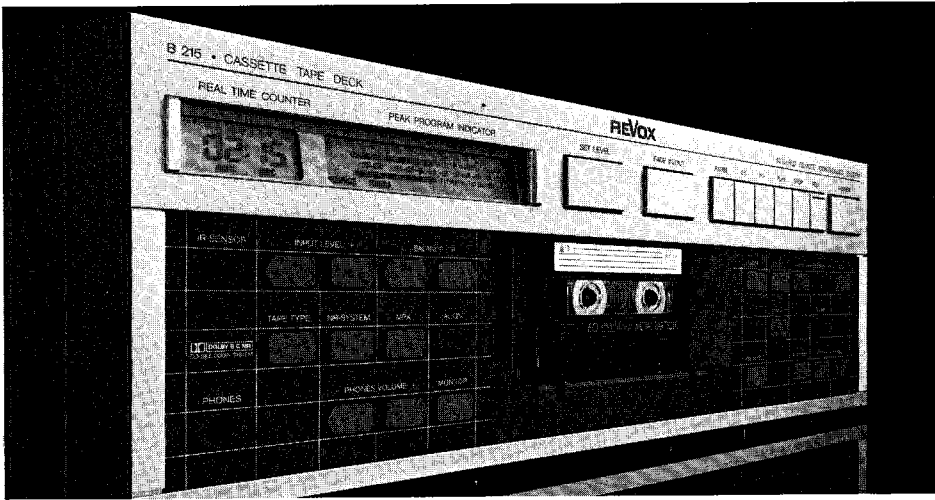

Because cassette recorders enjoy worldwide popularity, also in the professional sector, the manufacturers of recorders, cassettes, and tape materials have continually enhanced their products. But there is also a less positive development, particularly with respect to standards. Excellent results can only be achieved in conjunction with correct calibration, but in practice this is a problematical task. One suitable solution is automatic calibration.

Some thoughts on this topic are outlined in the following report by a development engineer.

A vast number of compact cassette types is currently available. In addition to the established tape categories such as iron oxide, chromium dioxide, ferric chromium and metal (corresponding to the IEC classification, I to IV), a finer differentiation is required within the individual categories, particularly in the case of IEC II. De facto there are two types, i.e. tapes with chromium dioxide content, and the Japanese chromium substitute tapes. Another aspect that stands in the way of long-term standardization is the fact that practically all manufacturers seek to optimize their price/performance ratio and therefore continually adapt their tape batches to their latest technological advances, frequently only in minor details, but sometimes major specifications are affected. Sometimes also marketing considerations play a decisive role. In one instant an excellent tape was "sacrificed" to the general

trend of tape characteristics simply to avoid being considered as an outsider with respect to competitive products.

The IEC recommendations with their target specifications have contributed little to standardization since the pro-

posed parameters are far below from the technically achievable today. In the meantime the trend now even goes so far that IEC attempts to adapt one of its reference tapes to today's average of the corresponding category. But all of this contributes to the fact that the buyer will in the foreseeable future not be able to work with any specific tape quality. A consequence of this odious situation was the successful introduction of auxiliary circuits in the form of calibration computers in cassette decks. This now also explains why such circuits are absent even in high-quality reel-to-reel recorders: there simply is no requirement for such a device because the differences between tape types are lower, the change extends over much greater time spans, and in addition the consequences from different parameters are far less dramatic at the speeds such tapes are processed. In following this trend, Studer Revox decided to equip its cassette recorders with a calibration computer.

Manual calibration

Let us first examine how a cassette recorder is calibrated manually. We assume that all mechanical adjustments have been performed correctly. The reproduction parameters are standardized and basically require no adapta-

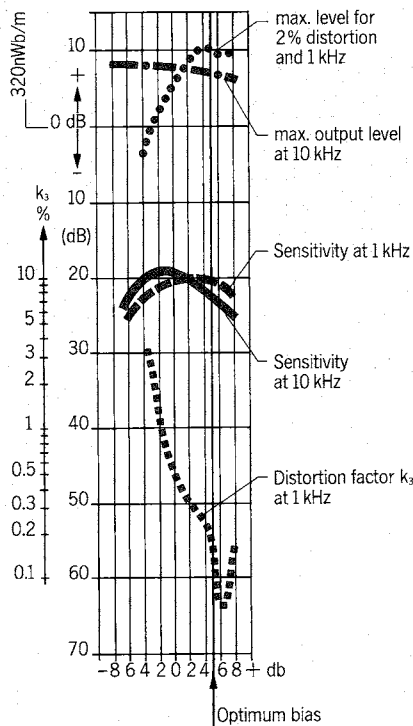

Reel-to-reel tape, track width 6.25 mm (1/4")
Tape speed: 15 ips
Tape type: ferric oxide
Gap width: 7 μm
Equalization: 35 μs

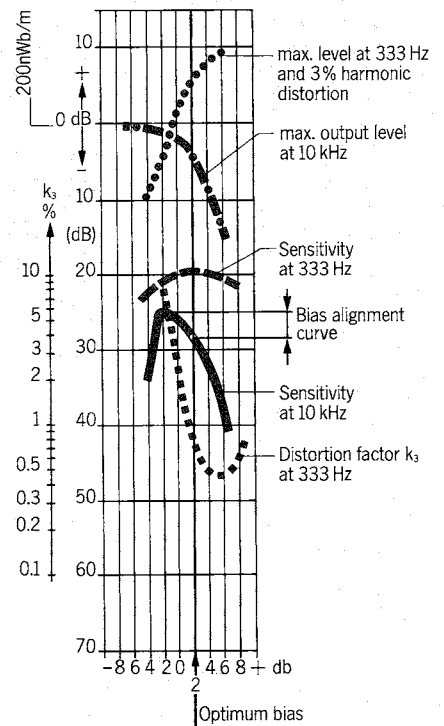

Cassette tape, track width 0.6 mm
Tape speed 4.75 cm/s
Tape type: chromium dioxide
Gap width: 4 μm
Equalization: 70 μs

Fig. 1

tion to the various tape types (except for the equalization). For nonprofessional units the record level, treble equalization, and the bias in the recording branch are specifically adjusted to the type of tape to be processed. The alignment of the bias is the most difficult operation. It represents a compromise between harmonic distortion at low frequencies and maximum recording level at high frequencies. Fig.1 illustrates the crucial parameters for iron oxide tape applicable to a reel-to-reel recorder and the chromium dioxide cassette tape. In contrast to the reel-to-reel recorder where the optimum bias practically coincides with the minimal distortion, the optimal setting for tape cassettes has shifted far to the left of this point because of the low tape speed. In practice, the bias is aligned at 10 kHz because the treble sensitivity is frequency-dependent. This value can vary more or less, depending on the tape type.

Calibration concept automatic/manual

Automatic calibration has the following inherent disadvantages over manual calibration: the tape type is initially unknown to the calibration electronics, i.e. no previously stored parameters can be taken into consideration. The computer must be able to cope with as many tape types as possible and with only a few interpolation frequencies. And how shall a local drop-out on the tape be interpreted? Based on extended observations, the human brain is very well able to ignore a transient error and to substitute a fluctuating value for an averaged one, or to ultimately resort to other measures such as using a different tape segment or to clean the heads. However, since there is no one correct value for the bias but a compromise must be found, it is not surprising that automatic calibration processes in equipment from different manufacturers produce different results. Let us briefly examine the three most frequently employed principles:

1. Constant bias: Level and treble equalization adjustable (optimal for tapes that conform to IEC specifications, problematic with more exotic tapes).

2. Constant treble equalization: Level and bias adjustable (produces good results for most tape types).

3. Vary bias until maximum sensitivity at a frequency of approx. 1 kHz is attained:

Level and treble equalization are also adjustable. (Calibration is difficult, particularly for tapes with many drop-outs. Does not produce an optimized working point for all tape types).

The B215 cassette recorder employs version 2 with an additional frequency response correction at around 4 kHz. This permits a nearly flat frequency response in the presence range where there are more pronounced differences between chromium substitute tapes and true chromium tapes.

B215 equipment design

Fig.2 contains an audio block diagram. The following circuit components have been added or laid out differently to accommodate automatic calibration:

- Test generator switchable to 3 different frequencies
- Recording level, equalizer, and bias must be controllable via the processor
- Measuring device with processor communication

Since in the B215 all functions are controlled by the processor, it made sense to use the output metering circuitry also for calibration, however, its sensitivity is now greater and the measuring characteristics are changed.

quick preliminary calculation which should point out that for proper calibration a considerable amount of time is needed. For 8 bits (= resolution of our level controller), the computation effort should not become too high; 8 measurements are necessary for each channel. Each time the value is changed, 100 ms are required before the tape is transported from the recording head to the reproduce head (head gap). With a 70 ms integration time constant of the rectifier, some 300 ms are required until the value is stable. For 8 measurements the straight waiting time thus exceeds 3 seconds.

At higher frequencies and for accurate results this time becomes even longer since a recording and a measurement cannot be performed simultaneously because of the strong cross talk from the recording head into the reproduce head. With a calibration time of 25 seconds the B215 cassette recorder is not one of the speediest, but this time should by all means be sacrificed for the sake of a good result.

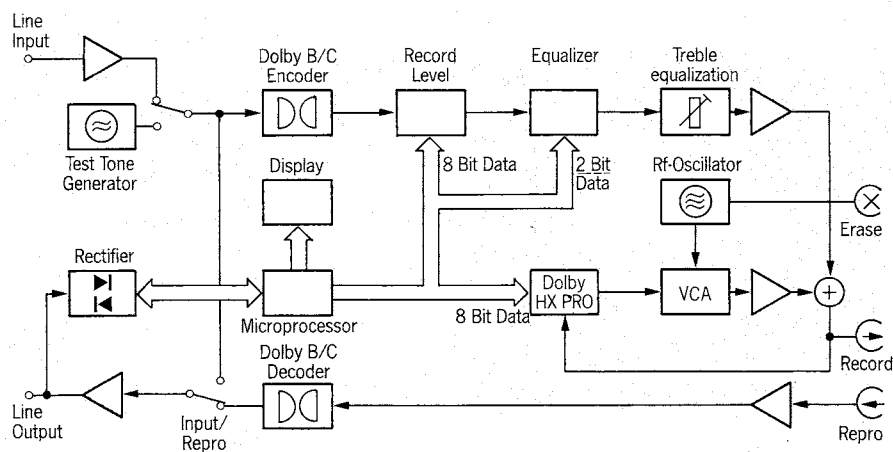

Fig. 2

This principle results in lower influence by component tolerances and in fewer alignment elements. The recording is not made with a fixed level, as is usually the case, i.e. the recording level is varied until a certain threshold in the reproduce path is attained. In the B215 the test tone is first measured without tape and the recording level is subsequently varied until the same value is attained with tape.

Time requirement vs. quality of the result

A calibration process should not strain the user's patience, i.e. it certainly should not exceed 30 seconds. Based on the level adjustment, we can make a

Calibration procedure

On the B215, calibration is performed in the following steps:

- Storing the current tape counter reading
- Coarse adjustment of the bias (with a test tone frequency of 17 kHz)
- Level adjustment (at 400 Hz)
- Bias fine-adjustment (17 kHz)
- Equalizer alignment (at 4 kHz)
- Rewinding the tape to the starting position



Meinrad Lienert (30) studied electrical engineering at the Swiss institute of Technology (ETH) in Zurich. After graduation in 1981 he joined Willi Studer AG as a development engineer. He developed audio electronics of cassette tape recorders A 710 and B215. Currently responsible project manager.

The bias and level are aligned separately for each channel by means of 8 bit digital/analog converters which corresponds to 256 steps. In the equalizer branch, the alignment is performed jointly for both channels by means of analog switches.

Meinrad Lienert

hard-working fellow-employees from the mixer production department and test bay, the mixing console was completed (with much overtime) before the weekend stipulated as the final deadline for installation. As a consequence the hectic shifted to the studio in Ostermundigen where the mixing console had to be installed. When dubbing of the film started on Sunday of the same weekend, some of the soldering joints were probably still hot!

The system in studio 1 is configured with the following equipment:

● **Mixing console Studer 906 A**

equipped with:

- 30 inputs, 6 stereo inputs
- 24 direct inputs to masters
- 24 direct inputs to internal Ghilmetti crossbar (all inputs equipped with VCA fader and limiter/compressor)
- Insert points switch-selectable before/after fader
- 24 master outputs with bargraph instruments
- 30 direct outputs, switch-selectable before/after fader
- 24-channel monitor mixer
- Insertable joy sticks (4-channel panorama potentiometers)
- Insertable 24-channel Dolby for A800-24
- Built-in patch bay with 864 bantam jack sockets

Also built into the mixing console are:

- Operating panel for Studer system controller SC 4008
- Operating panel for Sondor perfo machines
- Ghilmetti crossbar in panel with 32 inputs to 6 monitoring outputs

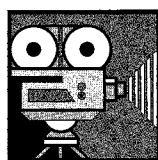

New studio for film dubbing in Dolby stereo at Schwarzfilmtechnik AG in Ostermundigen/Bern, Switzerland

The challenge

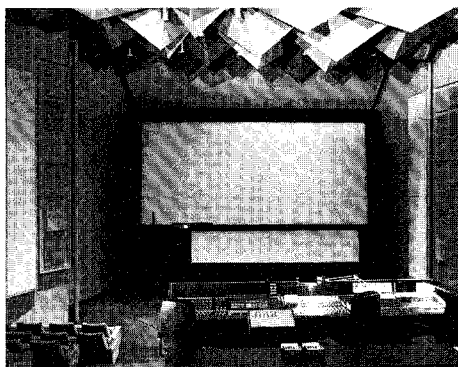

Film dubbing at Schwarzfilmtechnik AG Ostermundigen/Bern, Switzerland.

The first Swiss film dubbing studio for 4-channel sound with Dolby stereo is in operation since May 1986. The concept has been realized by Schwarzfilmtechnik AG in cooperation with Mr. F. Musy and the firms of Studer, Sondor, and Dolby.

The first contacts with the management of Schwarzfilmtechnik AG concerning the procurement of a new technology for the large studio 1 took place in the middle of 1985. These led to the design of a nearly standard version of the Studer series 900 with automatic fading, as well as synchronization of various tape recorders, perfo machines, video recorders, and film projectors with the aid of the Studer system controller SC 4008. Then came the 'silence before the storm' until the beginning of last year when a mixing console

concept was forwarded, the scope of which pushes the limits of what is achievable with the series 900 technology. The length of the console was limited only by the size of the largest freight elevator in our factory. The specifications as such posed no real problems, something that cannot be said for the April delivery deadline announced in February.

This deadline had to be met because the first dubbing of a Swiss film in Dolby stereo for the Cannes Film Festival was only achievable with this console. Because of the immense effort of Mr. Wehrlin of the studio planning department and a number of exceedingly



Studer mixing console type 906 A in studio 1.

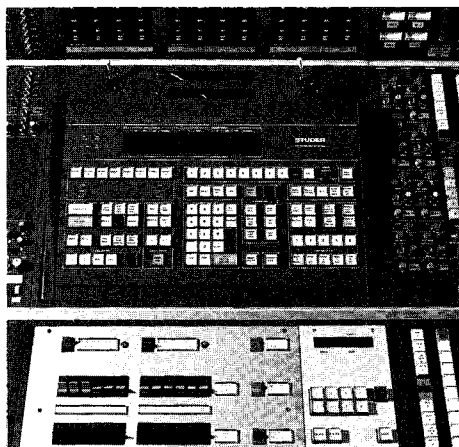

Detail view of the Studer mixing console with system controller SC 4008 (top) and remote control of the Sondor tape players (bottom).

Connected to the mixing console are:

- Master mix mixing computer for VCA faders
- XP24 Dolby, 24-channel noise reduction system

● **Studer A800 MK III 24-track tape recorder (2")**

With the time code technique, nonperforated 2" tapes can be synchronized with traditional perfo tapes. For example in a 35 mm mixdown, 'premixing' to the 24-track machine is possible without having to combine the individual mixing components on a single track. In combination with the mixing console automation, very fast changes in the final mix from 2" tape are possible.

● **2 Studer A810 2-track tape recorders (1/4") with additional time code track**

● **6 Sondor OMA S perfo tape players 35 mm**

All machines are equipped for 3- and 4-track reproduction; three of these machines also for 6-track reproduction.

In combination with the Unitor projector and the Studer 24-track machine, the maneuvering speed is up to 10 times greater and results in much shorter processing times for 35 mm films.

Two tape players are equipped as recorders with 3-, 4- or 6-track heads. This means for example that in a 4-channel final mixdown, voice, effects and music ($4 \times 3 = 12$) can be recorded on individual tracks.

● **Sondor light strip (chenille) and footage counter**

● **Studer SC 4008 synchronizing system**

This system controller can be used not only for machines controlled by time codes (video and multitrack machines) but also conventional perfo machines can be synchronized with each other.

Through the highly flexible software it is, for example, possible to form an electronic loop for postsynchronization of film and video.

● **Perfectone Unitor film projector**

Film projector with continuous film transport for 16 mm and 35 mm film operating at up to 30-fold nominal speed in forward and reverse direction. Film loops for postsynchronization are not needed because the loop is programmable (rock-and-roll operation). The continuous, smooth film transport prevents hard wear on the working copy containing splices.

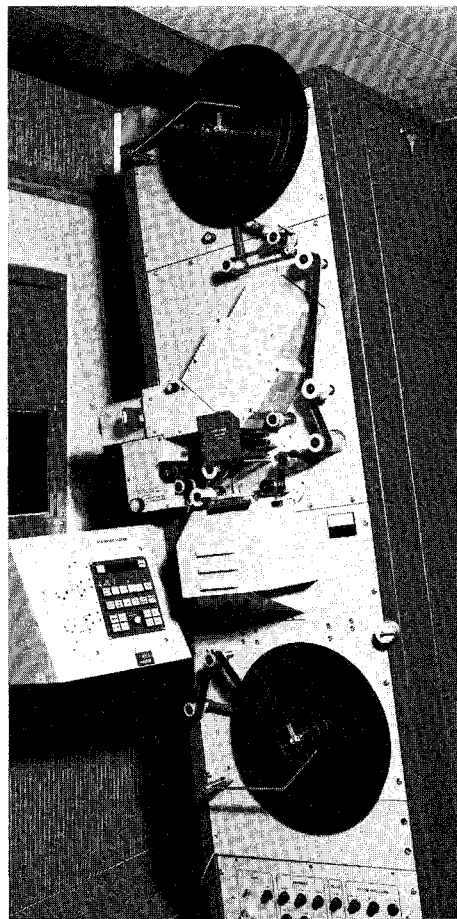

Unitor projector with continuous film transport for 35 mm and 16 mm film.

● **Atlas rhythm strip projector**

Below the screen a synchronously running footage or seconds rhythm strip is projected that permits highly accurate timing of the mixdown. The rhythm strip projector can also display each text passage at the precise entry point in postsynchronizations.

● **JBL monitoring**

Behind the newly installed screen, three JBL 4675 speakers (left, center, right) have been set up which are controlled by three JBL 6260 amplifiers delivering 300 Watts each. A fourth amplifier supplies over ten JBL 4401 speakers with the surround channel in Dolby stereo mixdowns.

In addition to 4-channel Dolby stereo also 2-channel stereo or mono mixdowns can be produced.

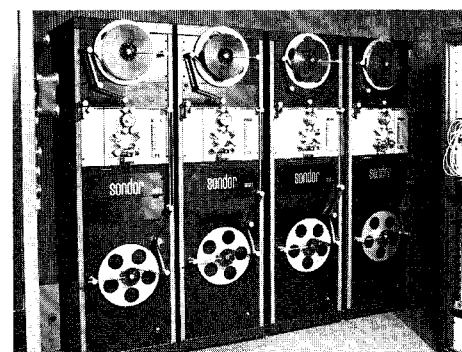

● **Westrex 35 mm mono/stereo sound-on-film camera**

● **Peripheral devices**

The latest digital effect devices are arranged behind the mixing console:

- Lexicon 224 X digital reverberation unit (2-channel)
- ams harmonizer model dmx 15-805 permitting voice pitch shift by up to one octave, e.g. when the film speed is changed from 24 to 25 frames/sec; digital sound loop storage
- Lexicon PCM 70, digital effect processor with 90 programs for reverberation and delay effects
- Lexicon PCM 42, digital delay processor
- dbx 900, equipped with two De-essers 902 and two Noise Gates 904
- Two Dolby film processors, filters, e.g. for suppressing camera noise
- Two Urei 1178 compressor/limiters (2-channel)
- Urei 565 T Little Dipper, filter for suppressing unwanted noise
- Urei 539, graphic equalizer with 1/3 octave steps
- dbx 120 subharmonic synthesizer for boosting the bass frequencies (boom-box)
- Aphex 602B Aural Exciter, for boosting the presence of music recordings
- 30 Dolby noise reduction modules
- Studer A725 CD player and Studer A710 cassette recorder

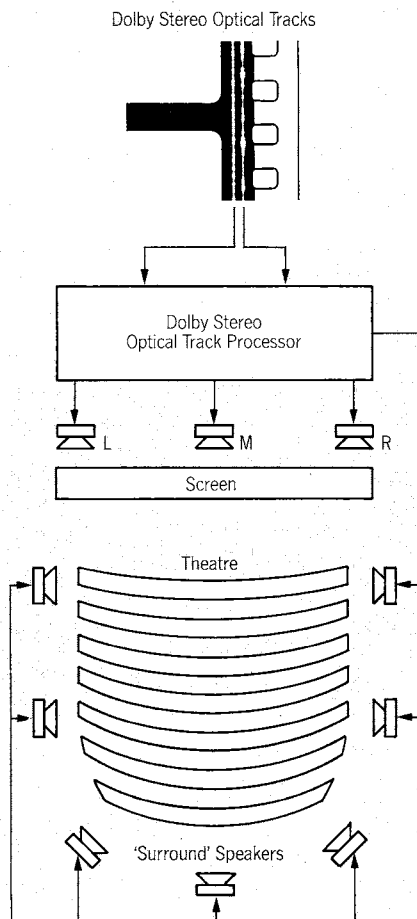

What is Dolby stereo?

Dolby stereo is a high-quality, 4-channel sound for the motion picture theater. Three channels are located behind the screen and a fourth, surround or effect channel, 'surrounds' the audience. It permits reproduction of a broad spectrum of sounds, from lifelike voices and subtle sound atmospheres or sometimes powerful music, to spectacular sound effects with an enormous depth effect.

Dubbing in Dolby stereo helps the producer to achieve greater audience involvement in the action on the screen and consequently to enhance the cinema experience.

Dolby stereo has become the film industry's standard for excellent sound reproduction through which films are produced under virtually the same listening conditions that are experienced by the visitors of a motion picture theater.

Bernhard Kohler

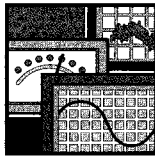

Studer Compact Mixing Consoles, Series 963

Larger inside than outside

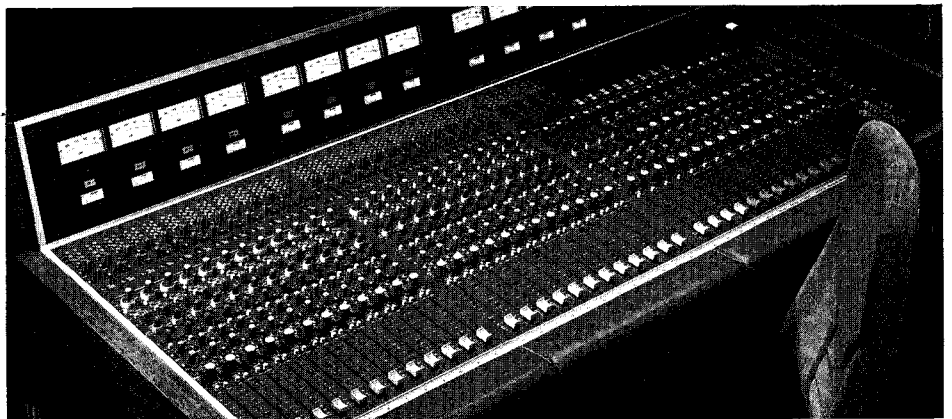

Fig. 1: Compact, clearly arranged and flexible, Studer 963.

It is probably in the nature of studio engineering that the frequently complex requirements and the available space are inversely proportional. For example OB vans, sound reinforcement installations in theaters, and dubbing studios generally are very demanding with respect to capabilities, but pose the greatest space problems. The new, very compact Studer 963 mixing consoles are based on an advanced technology that ensures not only excellent specifications but also requires a minimum of space. The following report outlines the design, modular concept, and application range of this versatile audio mixer technology.

To reduce the space requirements, a module width of 30 mm has been selected such as is also the case for the series 961/962 (by contrast the series 900 has a module width of 40 mm). To permit optimum utilization of the space available for the mixing console, 2 chassis of different size are available:

- Version A for 12 modules, width 386 mm
- Version B for 16 modules, width 506 mm

By combining these two chassis, consoles with a capacity of 24 to 50 modules/group modules can be assembled in a virtually custom configuration (Fig. 3). The only restriction in the combination of these chassis is that one of type A must be located on the far right. This unit (Fig. 2) contains:

- The master modules (masters 1...4)
- AUX 1...AUX 4, master
- Monitoring control room/studio
- Intercom and signalization
- Connector panel with bantam (TT) sockets.

The mixing console is designed for 8 group bases and 4 master buses, but not all group and master modules need to be configured. Configurations with only 4 groups and 2 masters are possible, but it is also possible to leave out the group modules completely. Additional input modules can be installed in place of the eliminated group modules.

Mixing console concept

The design objective of the Series 963 was to combine outstanding audio quality, high reliability, universal applicability, variable configuration, and compact size. With respect to low noise level and frequency response, this console is highly suited for PCM (signal-to-noise ratio: 1 channel selected: 93 dB).

Since field-effect transistors are used as AF switching elements, the switching functions in the input modules are not subject to wear and are insensitive to environmental influences.

Up to 12 main outputs (8 groups, 4 masters) are available, plus 4 auxiliary masters and direct outputs, as well as tape inputs in all input modules. All inputs and outputs are balanced and carry line level +6 dBu (except microphone inputs). With the comprehensive signalization, remote control, and intercom facilities, it is possible to satisfy all application requirements.

The modular design (also in the connector panel) simplifies the service work and permits many variations in the configuration of the desired mixing console.

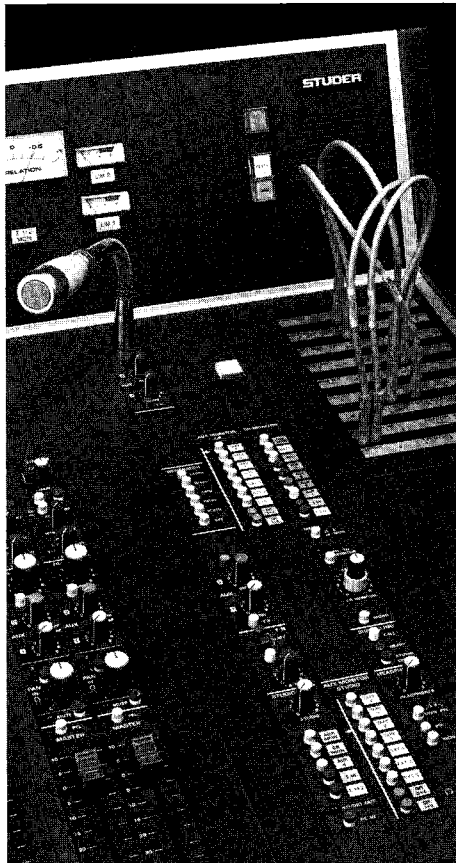

Fig. 2: Comprehensive monitoring facilities despite small size, incl. compact patch panel.

Main characteristics of the audio mixer modules

The «MONO» input module is used for connecting single-channel signal sources. The signal can be processed (preamplification, insert point, equalizer, level controller, auxiliary outputs) and distributed via the output selector keys and panorama potentiometer to a maximum of 12 buses. Specifics:

- Newly developed microphone input. Combines the advantages of a balanced and floating transformer input with the excellent technical specifications of the transformerless input (combination of a zero-ohm transformer input with transformer-based series negative feedback).
- Separate inputs for MIC, LINE, TAPE and GEN (test generator). The sources are connected by means of FETs.
- Mixdown function for simultaneous changeover of all input units to the TAPE input.
- Defeat button for specific cancellation of the mixdown function.

- Equalizer can be bypassed with push button switch.
- Four individually controllable auxiliary outputs, connectible before/after the linear fader
- Linear fader with conductive plastic element.
- Removable MUTE key.
- Output selection of the 8 groups and the 2 or 4 masters with 10 or 12 buttons respectively and panorama potentiometer.
- Electronically balanced direct output, can be tapped selectively before or after the linear fader.
- Electrically isolated remote control output via relay contact.

- Limiter/compressor section with PDM (pulse duration modulation) control circuit. Usable as a line protection limiter in the master channel or via patch panel cable as a compressor in any input channel.

The **studio monitor, AUX and command module** comprises four separate function blocks:

- Studio monitoring section with source selection, volume controller, and automatic insert interruption when the microphone channel is open.
- Master controller for the 4 auxiliary outputs AUX1...AUX4 with talk-back buttons.

OVERALL WIDTH	INPUT MODULE	CONSOLES WITH 4 GROUPS			INPUT MODULE	CONSOLES WITH 8 GROUPS			BASE FRAMES ASSEMBLY
1230 mm	20	[Diagram: 4x2 grid]			16	[Diagram: 4x2 grid]			A+A+A
1350 mm	24	[Diagram: 4x3 grid]			20	[Diagram: 4x3 grid]			B+A+A
1470 mm	28	[Diagram: 4x4 grid]			24	[Diagram: 4x4 grid]			B+B+A
1616 mm	32	[Diagram: 4x5 grid]			28	[Diagram: 4x5 grid]			A+A+A+A
1736 mm	36	[Diagram: 4x6 grid]			32	[Diagram: 4x6 grid]			B+A+A+A
1856 mm	40	[Diagram: 4x7 grid]			36	[Diagram: 4x7 grid]			B+B+A+A
1976 mm	44	[Diagram: 4x8 grid]			40	[Diagram: 4x8 grid]			B+B+B+A
		INPUT MODULES	GROUPS	MONITOR STECKFELD		INPUT MODULES	GROUPS	MONITOR STECKFELD	

Fig. 3: Selection of possible mixing console configurations.

The «STEREO» input module features a stereophonic high-level input. The processing facilities are the same as for the «MONO» module, except that the stereo module can be optionally equipped with or without equalizer. This module is also 30 mm wide, the operator controls act on both channels simultaneously.

The **group module** is used for adjusting the group signal. It is also equipped with a limiter/compressor as well as a high-level input that can be switched between the output of the group and a TAPE input.

The **master module** is designed in the same way, however, the high-level input cannot be changed over because it is intended only for external sources.

- Master section with balanced insert point, linear fader, and prefader listening.
- High-level input with rotary potentiometer, auxiliary outputs, and output selection with 2 or 4 keys and panorama potentiometer.

- Talk-back microphone and amplifier
- Test generator with 5 fixed frequencies

The **control room monitoring module** is used for selecting the monitoring sources for the control room, for selecting the sources for the headphones sockets, and for controlling the call lamp signals.

- Control room monitoring with separate volume control and selector for separate or simultaneous listening of the monitor source and prefader listening.
- Headphones monitoring with separate volume control and selector switch for separate or simultaneous reproduction of monitoring source prefader listening.
- Signal buttons for red, green, and yellow light.

The **auxiliary monitoring module** extends the control room and studio monitoring facilities by 9 additional sources.

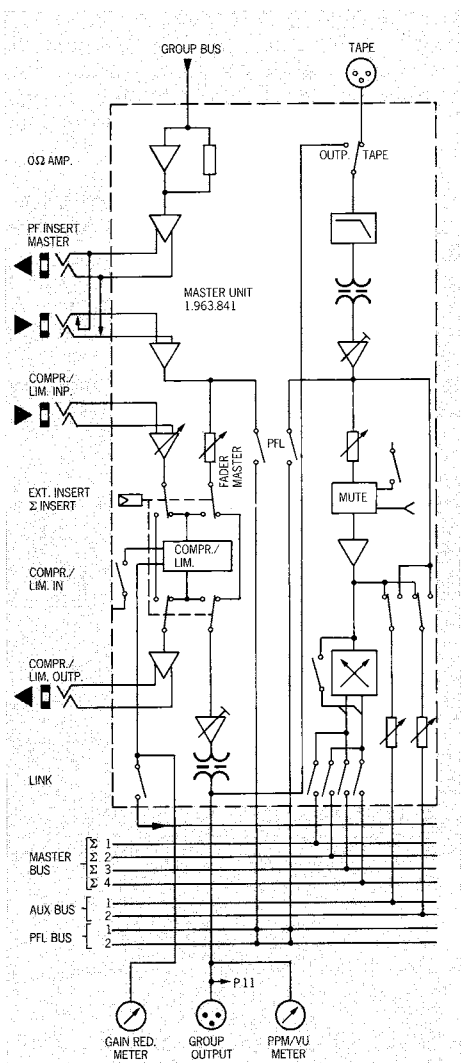

Fig. 4: Block diagram of group module 963.

The **instrument panel** extends across the full width of the console and can be configured to suit various requirements:

- As main instruments for groups and masters either peak program (PPM) or VU-meters are available. In place of needle-type instruments, bargraph instruments can be used.
- Each compressor/limiter has its own needle-type instrument for indicating the gain reduction.
- Correlation meter with needle-type instrument can be installed.
- The output levels of the auxiliary masters AUX1...AUX4 are displayed on 4 small needle-type instruments (internally switchable to PPM or VU characteristic).
- A prelistening speaker reproduces the PFL (prefader listening), the P-SOLO (positional solo) and the intercom signal from the studio.

- Three signal lamps indicate the status of the studio signals (red, green and yellow light).

Flexibility: the key feature

To illustrate the flexibility of the 963 mixing console we shall explain the group module in more detail (Fig. 4).

Behind the zero-ohm amplifier which sums all signals fed to the group bus there is an **insert point** (electronically balanced) that is accessible at the patch panel where the external processing units can be looped in (filters, effect machines etc.). The group controller (linear fader) is followed by the **limiter/compressor module**. This module can be connected to the group channel (limiter function) by pressing a button or it can be connected externally via the patch panel (compressor function).

In order to maintain the balance also in stereo mode, two adjacent limiter/compressor modules can be coupled by means of the «LINK» button.

Multichannel tape machines can be connected directly to the group outputs and tape inputs. The high-level inputs on the group modules can be changed over between these two signals and consequently can be used as a **monitor mixing field**.

In a different application the tape input could be simply used as an additional **high-level input** (e.g. for reverb return paths). The level is adjusted by means of a rotary potentiometer. In addition to the mute function and PFL, the high-level input is also equipped with two adjustable branches (AUX1 and AUX2) as well as a switchable panorama potentiometer and selection facilities for 2 or 4 masters.

Boris Balin



Boris Balin (33)

After his higher school certificate (1972) he pursued a 3-year study of musical science and philosophy. Started his audio engineering study at the University of the Arts and at the Technical University of Berlin. From 1981 on he worked as a certified audio engineer in Studio 54, Berlin and took over its technical management (planning and implementation of own developments for Studio 54). Since 1987 Boris Balin is an assistant to the product manager for mixing consoles at Willi Studer AG.

Continuation with application examples in the next edition of SWISS SOUND.

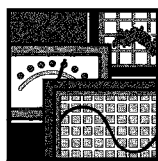

The B251 and its Damping Coefficient

The damping coefficient indicates the relation between output resistance and load resistor. To calculate the damping coefficient the following formula has to be applied:

$$d = \frac{U_L}{U_O - U_L}$$

- d: damping coefficient
 U_O : output voltage, measured with disconnected load
 U_L : output voltage, measured at loudspeaker clamps, with connected load

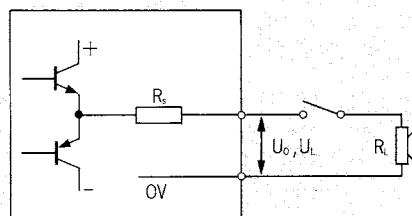

The formula to calculate d with known resistance values reads as follows:

$$d = \frac{R_L}{R_S}$$

- R_L : load resistance
 R_S : amplifier source resistance

The damping coefficient of the B251 amplifier can be determined by applying following data:

with 4 ohms charge:

$$d = \frac{R_L}{R_S} = \frac{4}{0.057} = 70.175$$

with 8 ohms charge:

$$d = \frac{R_L}{R_S} = \frac{8}{0.057} = 140.35$$

The above example shows that the damping coefficient improves with increasing load resistance.

Since the loudspeakers are placed several meters away from the amplifier, the loudspeaker cables also have to be taken into consideration. The amplifier output resistance is composed as follows – connecting cables considered:

$$R_{\text{tot}} = R_S + R_{\text{cables}} = R_S + \frac{\rho \cdot 2 \cdot L}{A}$$

R_{cables} : loudspeaker cable resistance
 ρ : specific resistance of copper at 1 m length and 1 mm² section
 ≈ 0.0172 to 0.0178 ohm at 20°C
 $2 \cdot L$: twice cable length in meters (outgoing and ingoing lines)
 A : section in mm²

The following chart shows the line resistance in ohms for various cable lengths and sections of copper cables ($\rho = 0.0178$):

cable length in m (outgoing and ingoing lines)	section in mm ²				
	0.5	0.75	1	1.5	2
5 (10)	0.356	0.237	0.178	0.119	0.089
10 (20)	0.712	0.474	0.356	0.238	0.178
15 (30)	1.068	0.711	0.534	0.357	0.267
20 (40)	1.424	0.948	0.712	0.476	0.356

For the Revox B251, R_S is 0.057 ohm. For a 4 ohms loudspeaker with 10 m cable length and 0.75 mm² section, we calculate the following damping coefficient:

$$d = \frac{R_L}{R_S + R_{\text{cables}}} = \frac{4}{0.057 + 0.474}$$

$$= \frac{4}{0.531} = 7.533$$

According DIN standards, the damping coefficient should not fall below $d = 3$, in other words, if $d = 3$

$$R_{\text{tot}} = \frac{R_L}{d} = \frac{4}{3} = 1.333 \text{ ohm}$$

i.e. according DIN standards a maximum 33.3% of the amplifiers effective power in R_S and R_{cable} may be lost.

This statement clearly shows that every modern amplifier is much better than its loudspeaker lines. Only in an active box all stated factors can be best possibly taken into consideration.

Bruno Baronio



The Studer Group

«Who is who»

This column has been reserved for introduction of personalities of our companies and representatives in Europe and Overseas.

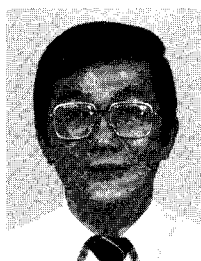

Val P. Ortega

Managing Director of Studer Revox Audio Pte. Ltd. in Singapore, daughter company of the Swiss exporting companies Studer International AG and Revox Ela AG • born 1948 and grown up in Singapore • graduate of various British and US universities and institutes in administration, marketing, purchasing and supply, general management • member of the 'British Institute of Management' • married, two daughters (7 and 11).

Before joining the Studer group in 1983, Val Ortega worked for Diethelm (Singapore) Pte. Ltd. (exclusive Studer Revox distributor until May 1983) as manager of the photo and hi-fi division, responsible for all marketing functions in S.E. Asia. His job did not only impart excellent know-how of the Singapore market, but acquainted him with business in the entire S.E. Asian market territories.

In 1983, when Studer Revox established the Studer Revox Audio Pte. Ltd. in Singapore, Val Ortega was appointed Managing Director. Chan Kheng Wah, electronic engineer, became technical head of the organisation and valuable cooperator in the young organisation. On account of territorial expansion of the company's activities, the crew was increased to seven and now jointly masters the requirements of the audio market.

The rapid growth of the professional audio market brought new activities for Val Ortega and his team. Through the medium of Studer products, first contacts were established with a sophisticated and demanding clientele of audio professionals.

The company is responsible for the markets of Singapore, Indonesia, Sabah

and Sarawak, Brunei and Burma, where regional distributors were appointed to sell Studer and Revox products to private customers and government institutions. The 'bumiputra' law takes care that national distributors exclusively obtain sole distribution rights; they also engage in marketing, sales and servicing and are supervised by the Singapore company.

Val Ortega's work is not restricted to his desk solely; he travels a great deal to the neighbouring countries and supports Studer Revox sales organisations in administrative and sales-orientated matters, whereas Chan Kheng Wah and K.S. Lee advise and train technical staff of both distributors and customers.

In general, the task of informing enjoys priority. Not only on travels but from the desk as well is information passed on to distributors and customers. In addition, Val Ortega's reporting system is exemplary and meets the requirements of the parent companies wholly – be these facts and figures of internal or market-oriented value.

The young team has meanwhile carried out professional project jobs in Sabah, Malaysia and Indonesia for broadcast and television companies; studios have been equipped with Studer and Revox products, and equipment has been supplied to individual users. The know-how and essential experience to tackle such jobs have been acquired and the team is well prepared for action.

More than in any other market, the company's activities are influenced by the prevailing economic situation. It requires great skill to utilize available sources and get ahead in business. While according to official reports Singapore shows signs of economic recovery, prospects in the attached markets are not very encouraging. The devaluation of the Rupiah in Indonesia, the drop in Malaysian oil prices create an economic draw-back, and heavily affect foreign imports.

Val Ortega closely observes the economic development in the areas of his



responsibility with a view to securing government orders and broadcast projects, as well as business in the recording and dubbing studio field and other institutional clientele; he also coordinates advertising and promotional campaigns in these regions.

Spare time is spent with the family; there is reading, music playing and a collection of coins to be looked after.

Val Ortega's unpretentious manners and his efficiency make him a valuable cooperator in the company group. Honesty and tolerance are his declared principles. We wish him and his team good luck and best success for the future.

Renate Ziemann

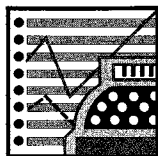

Right on success

**Studer
worldwide**

Yugoslavia

RTV Zagreb

In view of the forthcoming Universiade 87, RTV Zagreb have placed a large order for supply of one mixing console 904, two models 903, nine models 962, one multichannel tape recorder A800-24-2, 14 professional tape recorders A820-0.75, 27 A812-0.75 and five A812-2-TC VUK tape recorders. In addition, a synchronizer TLS 4000, four cassette recorders A710, three Tuners A726 and five CD-Players A725 were supplied.

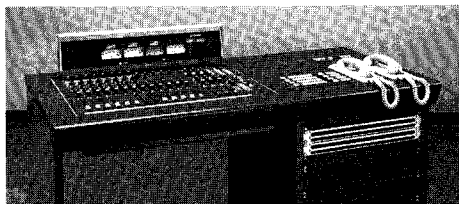

Special version mixing console 962 for continuity and production, with two telephones, telephone hybrid, patchpanel and four remote control units for A812 tape recorder.

Island

State Broadcasting, Reykjavík

The national broadcasting service of Island has ordered seven 2-track tape recorders type A820, of which three are models A820-0.75 and four A820-0.75 VU.

Egypt

ERTU, Cairo

The Egyptian Radio & Television Union (ERTU) in Cairo has ordered twelve A812 tape recorders with accessories, four 901 mixing consoles with supervisor console, and a 902B mixing console with master control room equipment. Training courses for the technical personnel have also been booked. The equipment is intended for the «Canal Regional Studio House», a regional studio located on the Suez Canal, and is scheduled for shipment in June/July.

Austria

ORF Vienna

End-February, an acceptance test was carried out for a mixing console Studer 904 A in the 36+6/16 VCA version. Purchased to be accommodated in OB-van 13 of the Austrian television company, the mixing console is of special design with regard to monitoring and signalisation. Limited space in the OB-van requires a compact layout of the equipment. In consideration of this, a new version console with card frame for a Europe-type PC board was explicitly built. For installation, it can be detached electrically and mechanically from the mixer. OB-van 13 will be ready for operation in Autumn 1987.

Luxembourg

RTL Luxembourg

A professional mixing console type 963 in a special version has been built and installed for the Studio 7 of Radio Tele Luxembourg. It comprises 9 microphone and 23 stereo input channels, 4 group, 2 master, and 1 mono output channel, tape remote control, and custom keypad modules. In addition a telephone talk-back unit has been integrated.



An additional special version of the 963 mixing console has been ordered by RTL for their Studio 9.

In March, we received the order for two tape recorders A820-2-TC VU and two synchronizers TLS 4000.

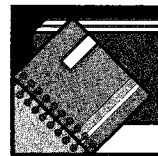

From the printers

10.23.1913	Brochure Studer (e)
10.23.1903	Brochure Studer (g)
10.26.0590	Data sheet A807 (e)
10.26.0580	Data sheet A807 (g)
10.29.1080	Leaflet 'Piccolo system' (g/e/f)
10.29.0251	Leaflet Revox Pro (e)
10.29.1090	Leaflet Revox Pro (g)
10.29.1100	Leaflet Revox Pro (f)
10.29.1110	Leaflet C279 (sp)
10.08.0690	Company brochure (sp)
10.90.1091	Company history 1948-86 (g)
10.90.1101	Company history 1948-86 (e)
10.90.1111	Company history 1948-86 (f)

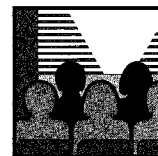

Studer Training courses

Tape Recorder A807	13.-15.5.87
Tape Recorder A810	18.-21.5.87
Synchronizer TLS 4000	21.-22.5.87
Tape Recorder A812	01.-03.6.87
Tape Recorder A820	04.-05.6.87

All courses are held in German. The courses are not fully booked yet. Each course takes 8-12 people and demands reasonable knowledge of electronics. Course fee is 110 sFr. per day.

Editors:

Marcel Siegenthaler, Franck M. Bürgi

Contributors of this issue:

Boris Balin, Bruno Baronio, Werner Hinn, Bernhard Kohler, Meinrad Lienert, David Walstra, Renate Ziemann

Please mail your letters to:

SWISS SOUND, STUDER INTERNATIONAL AG
Althardstr. 10, CH-8105 Regensdorf
Telephone +411 840 29 60 · Telex 58 489 stui ch
Telefax +411 840 47 37 (CCITT 3/2)

Art and production: Lorenz Schneider

Publisher: WILLI STUDER AG, Althardstr. 30, CH-8105 Regensdorf

Reprint permitted with reference to SWISS SOUND (please send a copy to the editor).

Dolby is a registered trademark of Dolby Laboratories Licensing Corporation.

Printed in Switzerland by WILLI STUDER AG
10.23.8210 (Ed.0487)

For further information please contact